

SECCION A-A

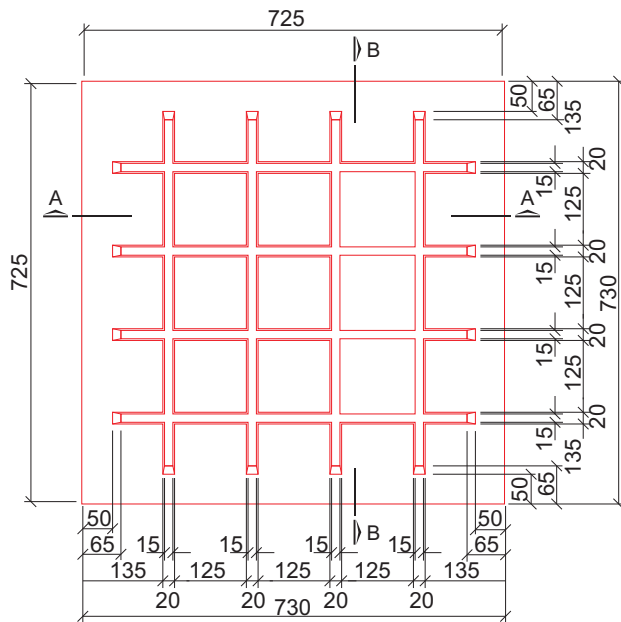

VISTA INFERIOR TAPA

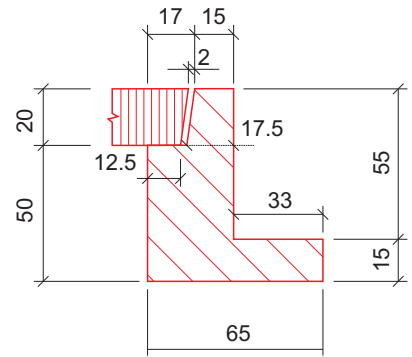

SECCION DETALLE MARCO

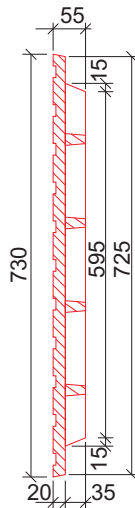

SECCION B-B

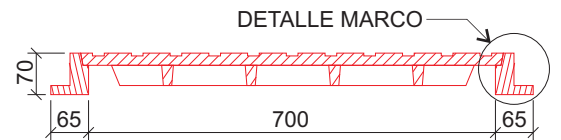

SECCION C-C

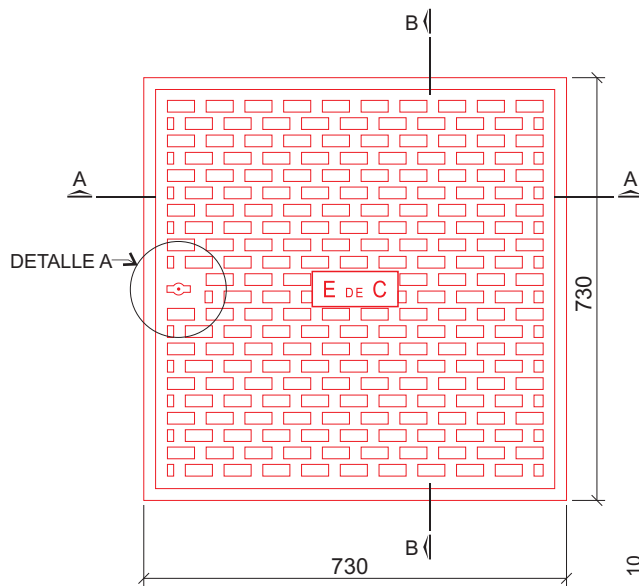

TAPA

SIMBOLO: 510070-3 / 11756

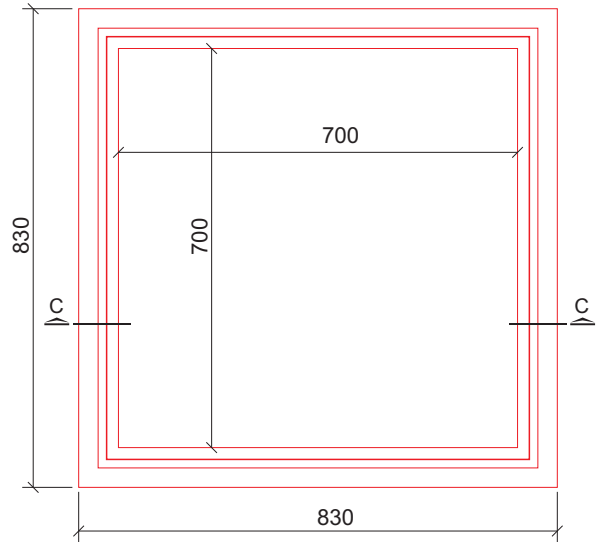

MARCO

SIMBOLO: 510076-6 / 11758

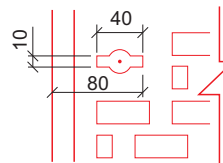

SECCION DETALLE A

NOTAS:

a) TODAS LAS MEDIDAS NO ESPECIFICADAS ESTAN EN CENTIMETROS

**MARCO Y TAPA DE HIERRO FUNDIDO
"TIPO REFORZADA" DE 70x70 (cm)
PARA TANQUILLA
(PARA USO DE ENTRADA DE GARAJE)**

